



















DUMPER D6

Technical data

	LOADING CAPACITY: Struck: 4500 l. Heaped: 6000 l.
	PAYLOAD: Kg 10.000.
	ENGINE: Diesel Perkins 1104 C-44 TA Turbo water-cooled, 4 cylinders. Maximum power 80 kW (107 HP), set at 2300 r.p.m.
	TRANSMISSION: Fully hydrostatic Bosch Rexroth with electric inverter. Gear box with mechanic control, two speeds. 4 wheel drive.
	AXLES: Dana Spicer with oil bath disc brakes and planetary reducers. Front axle steering and swinging. Rear axle fixed.
	SPEED: Working speed from 0 to 12 km/h, road transfer from 0 to 25 km/h.
	DRIVING SEAT: Reversible seat with automatic inversion of hydraulic steering circuits. ROPS-FOPS cab closed on 3 sides.
	BUCKET: Heavy duty rock type. Hydraulic tilting with 2 cylinders.
	CHASSIS: Steel profile specially engineered for off-road operations.
	HYDRAULIC SYSTEM: 2 independent circuits, variable outlet pump for hydrostatic transmission and hydraulic pump for services. Heat exchanger water-oil-air/air type.
	BRAKES: Oil bath disc brakes on 4 wheels. Hydraulic parking brake negative on rear axle manually operated.
	TYRES: Off road industrial type 16/70-20 14 PR.
	STEERING: Hydrostatic, "load sensing" type. Radius: (2 steering) internal 2900 mm, external 5800 mm.
	ELECTRIC SYSTEM: 12 Volt. 120 Ah battery for electric starter and road lighting. Safety battery cutoff.
	GRADIENT: Fully loaded 30%
	TANKS: Diesel: 115 l. Hydraulic oil 80 l.
	WEIGHT: Empty: Kg 5800.
	SAFETY: Machine equipped with checking and block valves for maximum safety of the operator.
	CATALOGUES: The machine is equipped with Use and Maintenance and Spare Parts Manuals.

Datos técnicos

CAPACIDAD DE LA CAJA: Enrasado: 4500 l. Colmado: 6000 l.
CAPACIDAD DE CARGA: Kg 10.000.
MOTOR: Diesel Perkins 1104 C-44 TA Turbo refrigerado por agua, 4 cilindros. Potencia máxima 80 KW (107 HP). Calibrada: a 2300 r.p.m.
TRANSMISION: Hidrostática Bosch Rexroth con inversor eléctrico. Cambio mecánico de dos velocidades. Tracción integral a las 4 ruedas.
EJES: Dana Spicer con frenos de disco en baño de aceite y reductores epicicloidales finales. Eje anterior directriz y oscilante. Eje posterior fijo.
VELOCIDAD: En trabajo 0 a 12 km./h, en desplazamiento 0 a 25 km./h.
PUESTO DE CONDUCCION: Asiento reversible 180° con inversión automática del circuito de dirección. Canopy ROPS-FOPS.
CAJA: Tipo roca. Elevación hidráulica con dos cilindros.
CHASIS: Construido en perfil de acero aleado para trabajar en las más duras condiciones.
SISTEMA HIDRAULICO: Dos circuitos independientes: bomba de caudal variable para la transmisión hidrostática y bomba hidráulica para servicios. Intercambiador tipo agua/aceite/aire-aire.
FRENOS: De disco múltiple en baño de aceite a las cuatro ruedas. Freno de estacionamiento hidráulico negativo en el eje posterior, operado manualmente.
NEUMATICOS: Tipo industrial, todo terreno, 16/70-20 14 PR.
DIRECCION: Hidrostática. Tipo "load sensing". Radio de giro (2x4) interno 2900 mm, externo 5800 mm.
SISTEMA ELECTRICO: 12 Volt. Batería de 120 Ah para arranque motor y sistema normalizado de luces para circulación por carretera. Desconector de batería de seguridad.
PENDIENTE: 30% superable a plena carga
CAPACIDAD DEPOSITOS: Combustible: 115 litros. Aceite hidráulico 80 litros.
PESO: En vacío Kg 5800.
SEGURIDAD: La máquina cuenta con las necesarias válvulas de control y bloqueaje para procurar la máxima seguridad al operador.
MANUALES: La máquina está equipada con los manuales de uso y mantenimiento y de las Piezas de Repuestos.



DUMPER D6

bidirectional

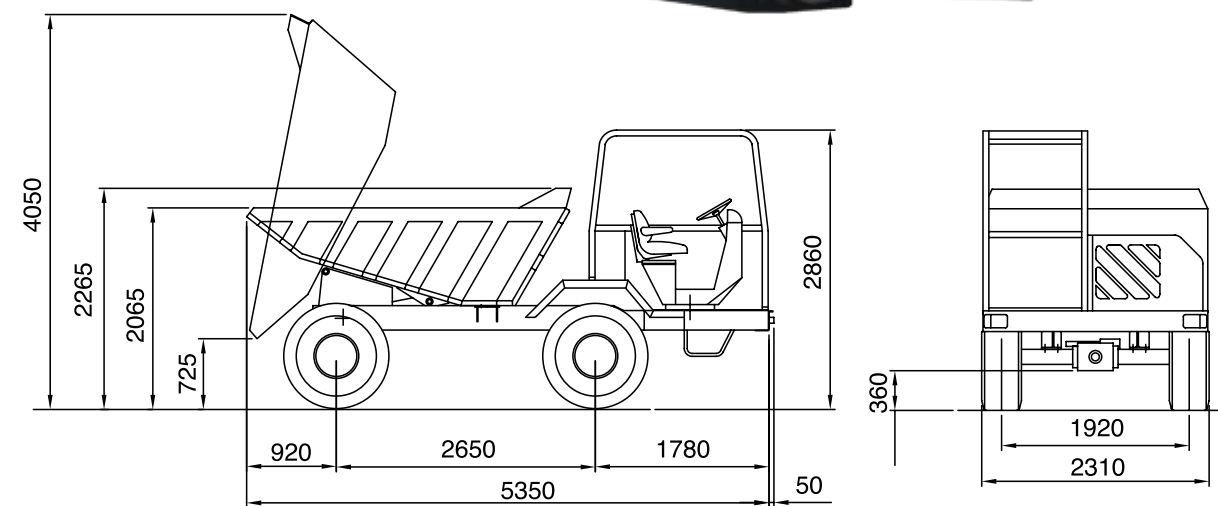

Metalgalante, the Company that invented and developed CARMIX, the No. 1 in the 4x4 Self-Loading Concrete Mixer. Thanks to 40 years of experience, CARMIX represents world-wide the Ideal Solution to produce high-quality cost-effective concrete wherever and whenever needed. From our Venice based factory, thousands of CARMIX have reached our Customers to over 130 countries matching their utmost expectations.

Metalgalante, el fabricante de CARMIX, sin alguna duda la AutoHormigonera AutoCargable TodoTerreno numero 1 en el mundo. Con una experiencia de 40 años CARMIX representa a nivel global la Solución Ideal para producir hormigón de alta calidad a bajo costo, donde y cuando se necesita. Desde nuestra fabrica cerca de Venecia, miles de CARMIX han llegado a nuestros Clientes en mas de 130 Paises del mundo, encontrando su maxima satisfaccion.



30020 Noventa di Piave (Venice) Italy
Tel. +39.042165191 - Fax +39.0421658838
info@carmix.com
Skype: carmix.main



carmix.com

Carmix Dumper D6 - Heavy Duty Dumper - Apollo Carmix



DUMPER D6

bidirectional

HEAVY DUTY DUMPER ESPECIALLY ENGINEERED FOR TUNNELING AND ROAD MAINTENANCE WORKS.

IDEAL PARA TRABAJOS EN TUNELES Y OBRAS VIALES





DUMPER D6

bidirectional



WHAT MAKES CARMIX NO. 1

- Wide driving ROPS FOPS cab to assure excellent comfort and safety to the operator.
- Hydrostatic transmission Bosch RexRoth
- Reversible driving seat for perfect visibility.
- Perkins Diesel engine 107 HP Turbo
- Heavy duty differential axles Dana-Spicer with planetary reducer.
- Oil bath built-in disc brakes: no maintenance at all and total reliability.
- Two hydraulic cylinders for tilting bucket.
- Over 40 years of experience on the toughest jobsites.
- Capacity: 6 m3; 10 tons.

LO QUE HACE CARMIX NO. 1

- Amplia cabina ROPS FOPS cerrada en los 3 lados para asegurar un excelente comfort y seguridad del operador.
- Transmision Hidrostatica Bosch RexRoth.
- Asiento reversible para una perfecta visibilidad.
- Perkins Diesel engine 107 HP Turbo
- Ejes diferenciales con reductores epicicloidales Dana Spicer.
- Frenos de disco multiples en baño de aceite: ningun mantenimiento y fiabilidad total.
- Dos cilindros hidraulicos para elevacion cajon.
- Mas de 40 años de experiencia en las mas dificiles obras del mundo.
- Capacidad: 6 m3; 10 toneladas.

ON REQUEST:

- Mixing unit 3.5 m3 to deliver concrete for special purposes.
- 4 wheel steering.
- Catalytic muffler.

OPCIONAL:

- Kit hormigonera de 3.5 m3 para aplicaciones especiales.
- Direccion en las 4 ruedas.
- Catalizador.

